

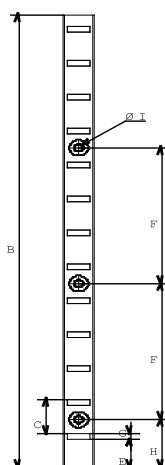

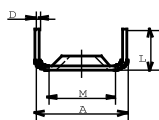

**CRÉMAILLÈRES et TAQUETS**  
***SHELF RAILS AND WEDGES***



# 11.1 CRÉMAILLÈRES ET TAQUETS

## 8750 | Crémaillère ACCORD à visser Acier galvanisé prélaqué





REF.	FINITION	AxB	C	D	E	F	G	H	I	L	M	 mm	 Kg 100 p.	 P
523 670	Chêne	14x2000	25	0,5	22	100	3	50	3,2	4,3	6,8	2,5	15	50
523 680	Blanc	14x2000	25	0,5	22	100	3	50	3,2	4,3	6,8	2,5	15	50
523 690	Argent	14x2000	25	0,5	22	100	3	50	3,2	4,3	6,8	2,5	15	50

Cotes en mm / Traitement anticorrosion multi-couches (galvanisation + laque)

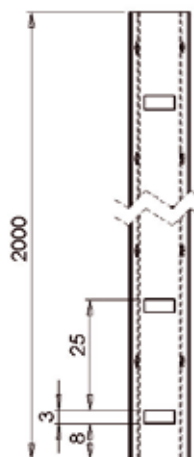
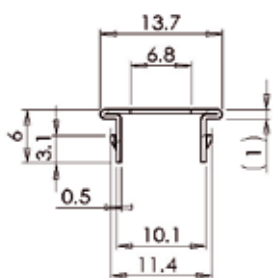
## 8700 | Crémaillère ACCORD à encastrer Acier galvanisé prélaqué



REF.	FINITION	AxB	C	D	 Kg 100 p.	 P
523 780	Blanc	14x2000	25	0,5	22,6	50

Cotes en mm / Interchangeable avec la crémaillère aluminium 8600 (entaille 11,3 mm)

## 8701 | Taquet simple ancrage P.O.M.

Hauteur 18 mm

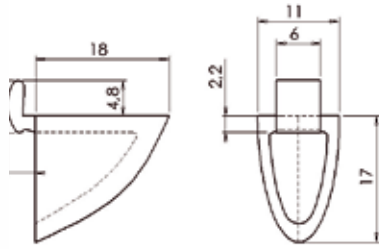

REF.	FINITION	AxB	Kg 100 p.	
523 850	Pin	17x18	0,13	100
523 870	Chêne	17x18	0,13	100
523 880	Blanc	17x18	0,13	100

Cotes en mm / Charge statique admissible : 100 kg pour 4 taquets

## 8702 | Taquet double ancrage P.O.M.

Hauteur 32 mm

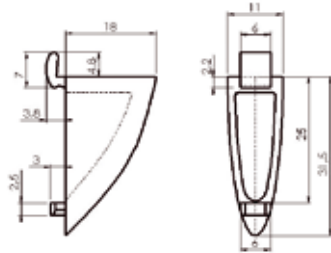

REF.	FINITION	AxB	Kg 100 p.	
523 970	Chêne	31,5x18	0,25	100
523 980	Blanc	31,5x18	0,25	100

Cotes en mm / Charge statique admissible : 180 kg pour 4 taquets  
reprise de charge par un 2ème ancrage

## 8705 | Taquet d'étagère P.O.M.

Hauteur 18 mm

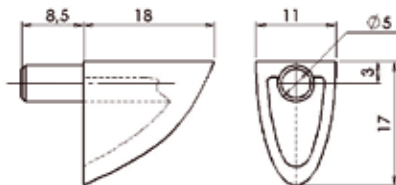

REF.	FINITION	AxB	Kg 100 p.	
520 630	Blanc	17x18	0,14	100

Cotes en mm

## 8900 | Crémaillère ACIER à visser Entraxe ajourage 15 mm

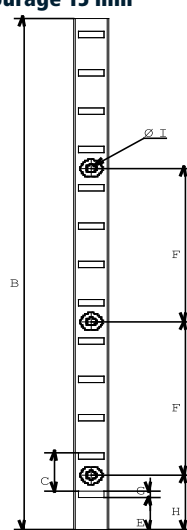
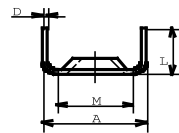





REF.	FINITION	AxB	C	D	E	F	G	H	I	L	M		Kg 100 p.	
522 310	Acier laitoné	11x2000	15	0,6	6,5	60	2,5	30	3,2	6	8	2,5 mm	16	50
522 005	Acier nickelé	11x2000	15	0,6	6,5	60	2,5	30	3,2	6	8	2,5	16	50
522 340	Acier laqué Blanc	11x2000	15	0,6	6,5	60	2,5	30	3,2	6	8	2,5	16	50
522 360	Acier laitoné	11x3500	15	0,6	6,5	60	2,5	30	3,2	6	8	2,5	28	30
522 370	Acier nickelé	11x3500	15	0,6	6,5	60	2,5	30	3,2	6	8	2,5	28	30

Cotes en mm

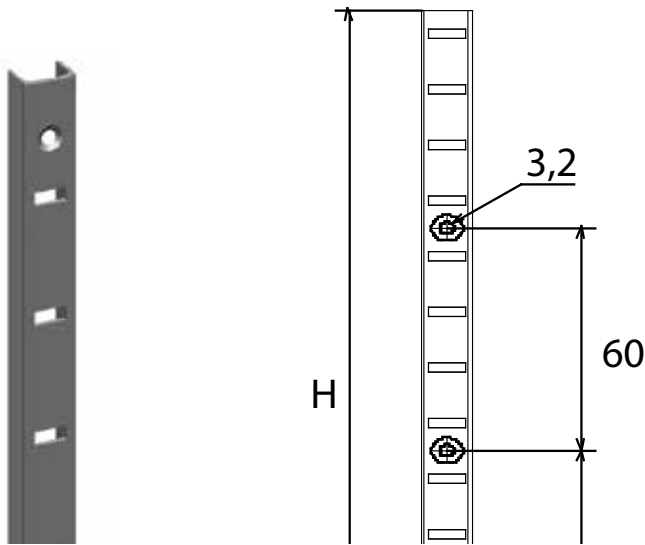
# 11.1 CRÉMAILLÈRES ET TAQUETS

## 8900 | Crémaillère ACIER à visser Entraxe ajourage 15 mm





REF.	FINITION	AxB	C	D	E	F	G	H	I	L	M	 mm	 Kg 100 p.	
522 010	Acier laitonné	16x2000	15	0,6	6,5	60	2,5	30	3,2	5	8	2,5	17	50
522 020	Acier Nickelé	16x2000	15	0,6	6,5	60	2,5	30	3,2	5	8	2,5	17	50
522 040	Acier laqué blanc	16x2000	15	0,6	6,5	60	2,5	30	3,2	5	8	2,5	17	50
522 050	Acier inox	16x2000	15	0,6	6,5	60	2,5	30	3,2	5	8	2,5	20	50
522 060	Acier laitonné	16x3500	15	0,6	6,5	60	2,5	30	3,2	5	8	2,5	30	30
522 070	Acier nickelé	16x3500	15	0,6	6,5	60	2,5	30	3,2	5	8	2,5	30	30
522 080	Acier laqué blanc	16x3500	15	0,6	6,5	60	2,5	30	3,2	5	8	2,5	30	30

Cotes en mm

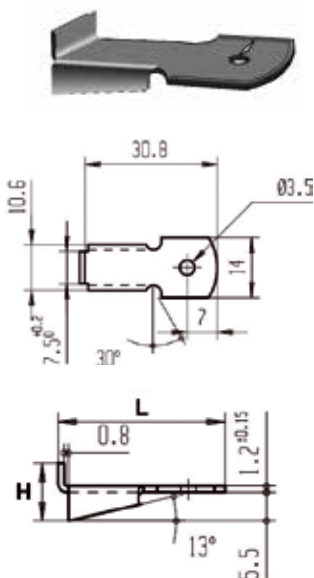
## 8901 | Taquet standard pour crémaillère ACIER Longueur 32 mm



REF.	FINITION	 Kg 100 p.	
522 110	Acier laitonné	0,45	200
522 120	Acier laqué blanc	0,45	200
522 130	Acier nickelé	0,45	200

Cotes en mm / Interchangeable avec la crémaillère acier galvanisé prélaqué 8700 (entaille 11,3 mm)

## 8650 | Crémaillère Aluminium à visser Entraxe ajourage 25 mm

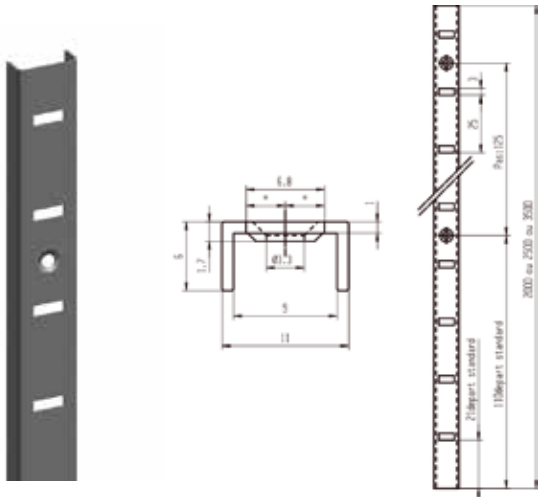

REF.	FINITION	AxB	Kg 100 p.	P
522 410	Anodisé argent	11x2000	12	50
522 420	Laqué blanc	11x2000	12	50
522 430	Anodisé or	11x2000	12	50
522 450	Brut	11x2000	12	50
522 620	Anodisé champagne	11x2000	12	50
523 600	Anodisé argent	11x3500	21	30

Cotes en mm

## 8600 | Crémaillère Aluminium à encastrer Entraxe ajourage 25 mm

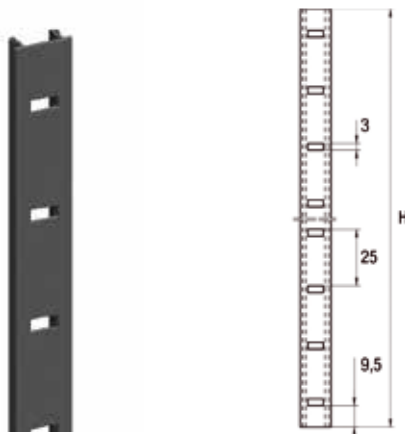

REF.	FINITION	AxB	Kg 100 p.	P
522 810	Anodisé argent	13,7x2000	14	50
522 820	Anodisé bronze	13,7x2000	14	50
522 830	Anodisé or	13,7x2000	14	50
522 840	Laqué blanc	13,7x2000	14	50
522 850	Brut	13,7x2000	14	50
522 600	Anodisé champagne	13,7x2000	14	50
522 750	Brut	13,7x2500	17,5	50
522 760	Anodisé argent	13,7x2500	17,5	50
522 770	Anodisé or	13,7x2500	17,5	50
522 790	Laqué blanc	13,7x2500	17,5	50
522 610	Anodisé champagne	13,7x3500	24,5	30
522 680	Brut	13,7x3500	24,5	30
522 690	Anodisé argent	13,7x3500	24,5	30
522 700	Anodisé or	13,7x3500	24,5	30
522 710	Anodisé bronze	13,7x3500	24,5	30

Cotes en mm / Interchangeable avec la crémaillère acier 8700 (entaille 11 mm)

## 8601 | Taquet standard Aluminium pour crémaillère Aluminium

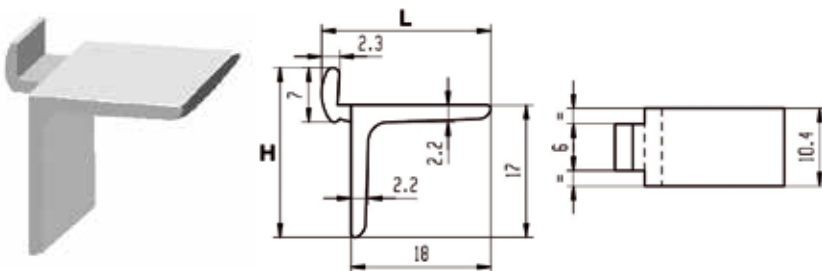

REF.	FINITION	Kg 100 p.	P
522 510	Anodisé argent	0,25	200
522 530	Anodisé or	0,25	200
522 540	Anodisé champagne	0,25	200
522 550	Brut	0,25	200
522 560	Laqué blanc	0,25	200
522 570	Anodisé bronze	0,25	200

Cotes en mm / Charge statique admissible : 220 kg pour 4 taquets

## 8604 | Taquet composite pour crémaillère Aluminium

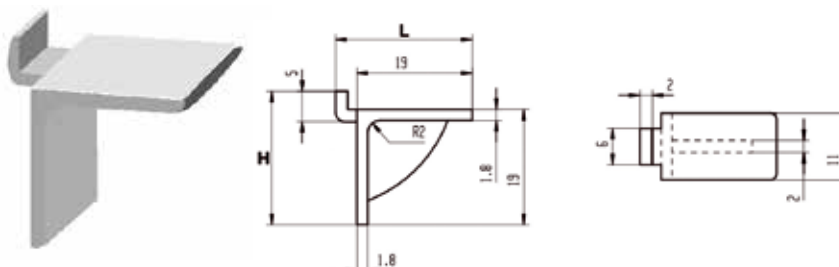

REF.	FINITION	Kg 100 p.	P
522 590	Blanc	0,13	200
522 650	Or	0,13	200
522 640	Argent	0,13	200

Cotes en mm / Charge statique admissible : 85 kg pour 4 taquets

## 11.2 TAQUETS SIMPLES

### I Taquet pour glace, zamac nickelé à ventouse Tige acier Ø 5 mm

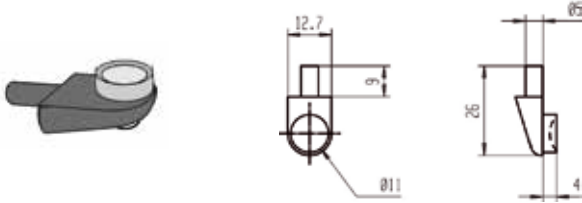

REF.	AxB	Kg 100 p.	
520 050	12,7x26	0,5	100

Cotes en mm

### I Taquet d'étagère laiton massif pour douille crantée Tige lisse Ø 6 mm

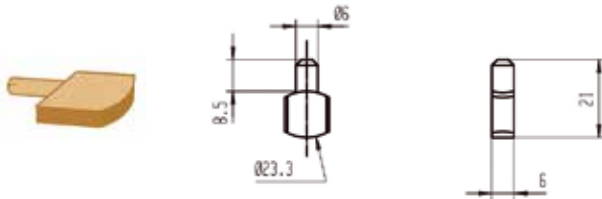

REF.	AxB	Kg 100 p.	
520 410	6x21	0,9	100

Cotes en mm

### I Douille crantée laiton massif Pour taquet à tige lisse Ø 6 mm

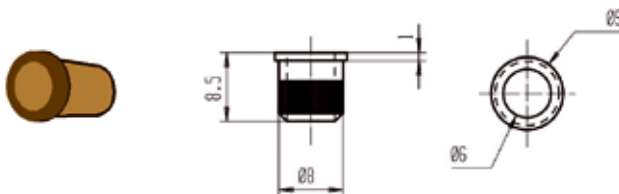

REF.	AxB	Kg 100 p.	
520 420	8,5x8	0,16	100

Cotes en mm

### I Taquet d'étagère pour douille cannelée Ø 7 mm

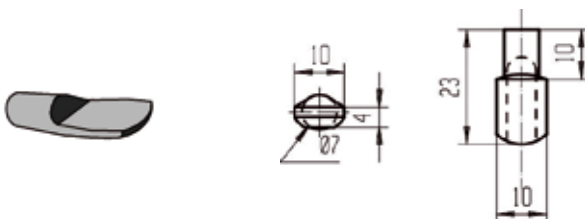

REF.	FINITION	AxB	Kg 100 p.	
521 010	Acier laitoné	23x10	0,6	100
521 030	Acier nickelé	23x10	0,6	100

Cotes en mm

### I Douille lisse laiton pour taquet acier Ø intérieur 7 mm - Ø extérieur 7,5 mm

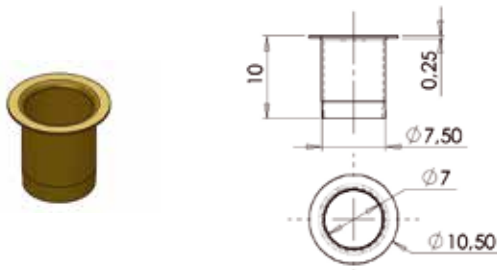

REF.	FINITION	AxB	Kg 100 p.	
521 120	Laitonné	7,5x10	0,06	100
521 140	Nickelé	7,5x10	0,06	100

Cotes en mm

### I Taquet d'étagère à visser Ø 4 mm

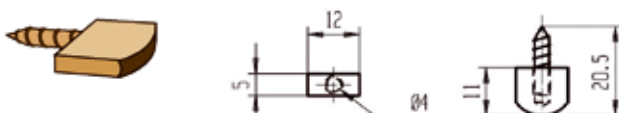

REF.	FINITION	AxB	Kg 100 p.	
521 310	Laiton massif	12x20,5	0,53	100

Cotes en mm

## 11.2 TAQUETS SIMPLES

### I Taquet d'étagère composite à clouer demi-rond Ø 15 mm

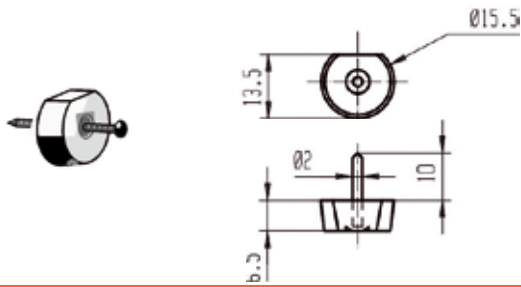

REF.	FINITION	AxB	D	Kg 100 p.	
521 410	Blanc	13,5x16,5	6,5	0,12	100
521 430	Marron	13,5x16,5	6,5	0,12	100

Cotes en mm

### I Taquet d'étagère Corps composite - tige acier Ø 5 mm

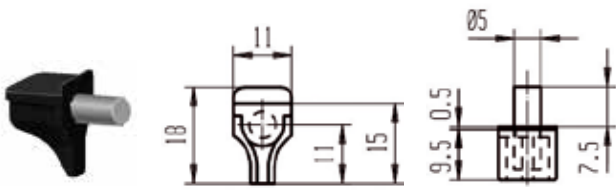

REF.	FINITION	AxB	D	Kg 100 p.	
521 510	Blanc	18x11	10	0,31	100
521 530	Marron	18x11	10	0,31	100
521 550	Translucide	18x11	10	0,31	100

Cotes en mm

### I Taquet d'étagère composite Tige Ø 5 mm

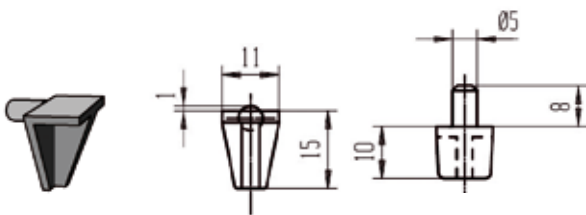

REF.	FINITION	AxB	Kg 100 p.	
521 610	Blanc	15x11	0,1	100

Cotes en mm

### I Taquet d'étagère à collerette A.N. Tige Ø 5 mm

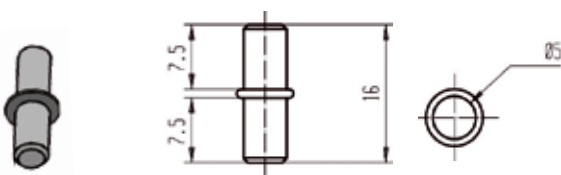

REF.	AxB	Kg 100 p.	
521 850	16x5	0,25	100

Cotes en mm

### I Taquet d'étagère Acier Tige Ø 5 mm

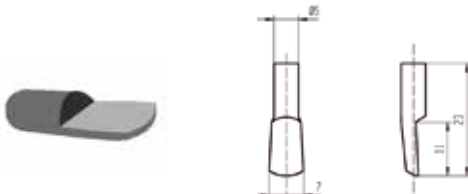

REF.	FINITION	AxB	Kg 100 p.	
521 880	Nickelé	23x7	0,3	100
521 890	Laitonné	23x7	0,3	100

Cotes en mm

### I Taquet «L» nickelé Avec tenon Ø 5 mm et ventouse

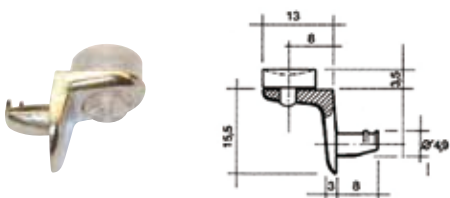

REF.	DIMENSION	Kg 100 p.	
520 060	21x19	0,4	100

Cotes en mm

# 12.1 ACCESSOIRES PORTES COULISSANTES

## 1602 | Galet à billes A.N. Billes en acier trempé / Gorge 4.8 mm

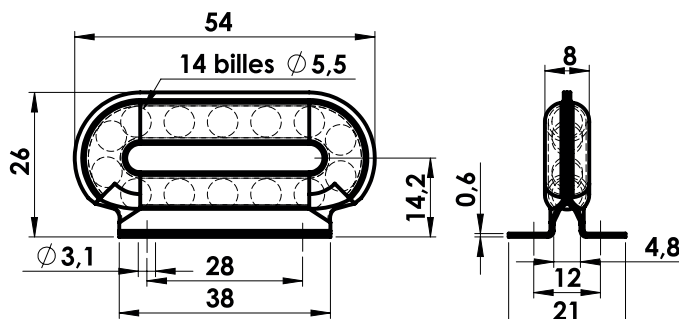

REF.	DIMENSION	100 p.	P
110 910	54x8	2,2	50

Cotes en mm

## 1602 | Galet à roulette nylon A.Z. Roulement silencieux / Gorge : 4,5 mm / Poids admissible 5 kg par galet

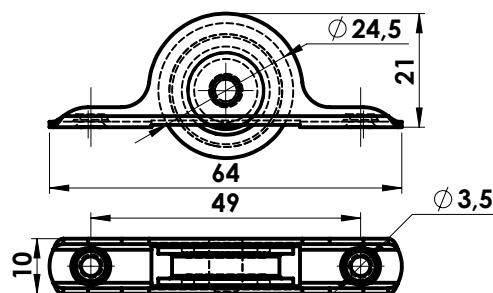

REF.	DIMENSION	100 p.	P
111 010	64x10	1,7	50

Cotes en mm

## 1602 | Galet à billes pour porte mince A.Z. Gorge : 4,5 mm / Poids admissible 10 kg par galet

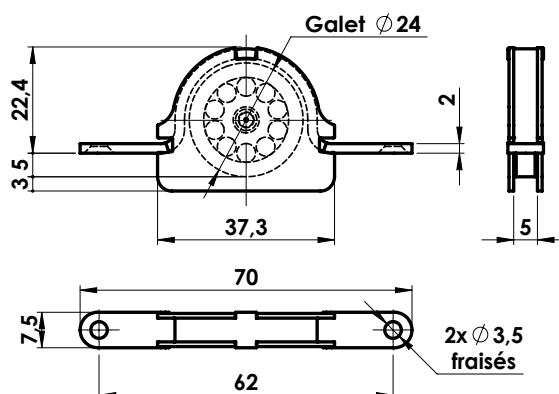

REF.	DIMENSION	100 p.	P
111 110	70x7,5	2,7	50

Cotes en mm



**1602 | Galet à billes pour porte lourde A.Z. Tout acier / Gorge : 5 mm / Poids admissible 15 kg par galet**

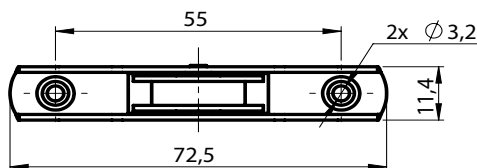
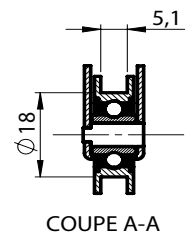
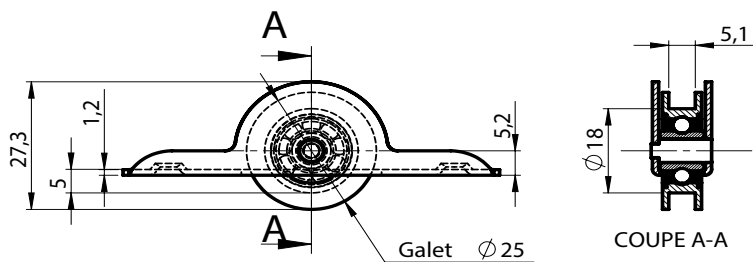

REF.	DIMENSION	Kg	100 p.
111 210	72,5x11,4	3,4	50

Cotes en mm

**Galet de roulement. Bas. Ø 30 mm. Nylon marron**

S'assemble avec références 111300 & 111340.

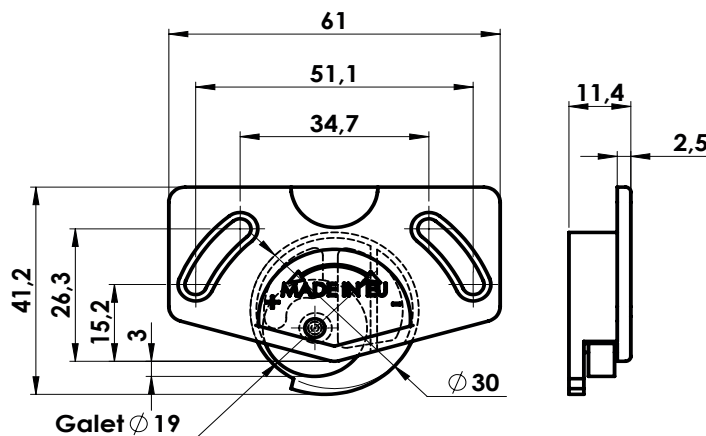

REF.	DIMENSION	Kg	100 p.
111 320	61x41,2	0,7	20

Cotes en mm

**1601 | Guide de haut simple A.Z. Avec galet nylon Ø 10 mm**

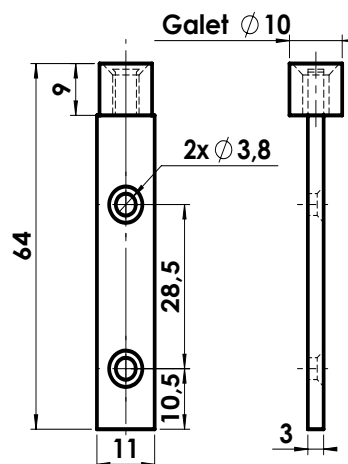

REF.	DIMENSION	Kg	100 p.
112 710	64x11	1,45	50

Cotes en mm

# 12.1 ACCESSOIRES PORTES COULISSANTES

## 1601 | Guide sur équerre à ressort A.Z. Montage automatique / Avec galet nylon Ø 10 mm

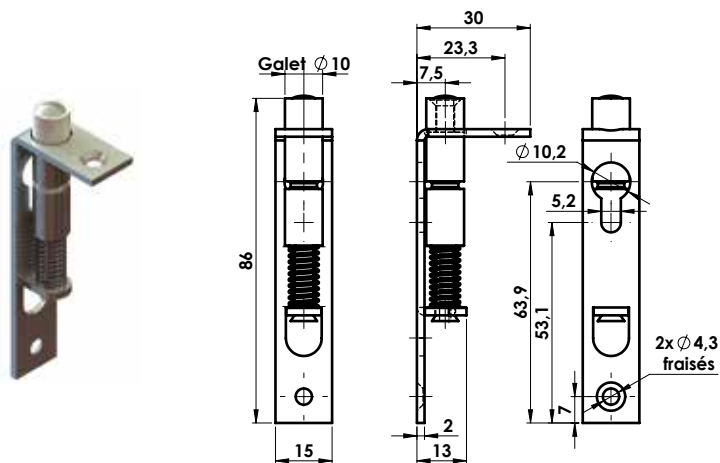

REF.	DIMENSION	Kg 100 p.	P
112 810	86x30	4,3	50

Cotes en mm

## 1601 | Guide sur équerre sans ressort A.Z. Galet nylon Ø 10 mm

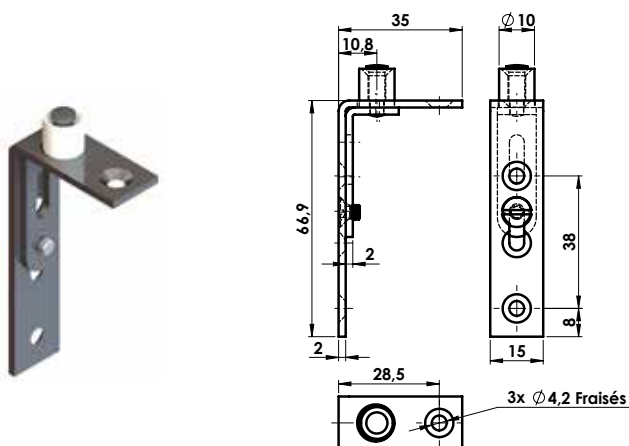

REF.	DIMENSION	Kg 100 p.	P
112 910	67x35	3	50

Cotes en mm

## 1602 | Patin nylon pour rail plastique blanc Gorge : 4,5 mm

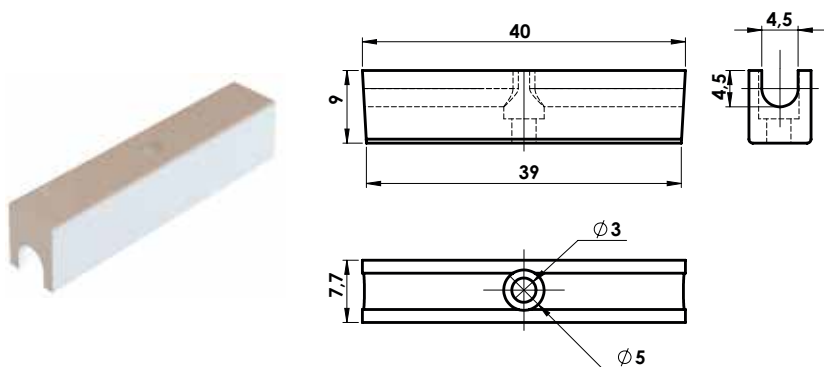

REF.	DIMENSION	Kg 100 p.	P
113 710	40x9	0,22	50

Cotes en mm

## 1603 | Rail A.Z. Conditionnement par 25 longueurs de 2 m

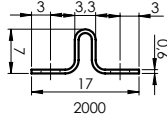

REF.	DIMENSION	100 p.	P
123 310	2000x15	23,5	25

Cotes en mm

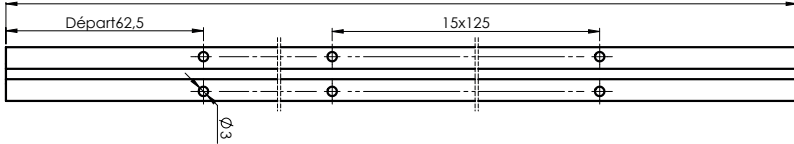

## Rail composite largeur 16 mm Conditionnement par rouleau de 25 m



REF.	FINITION	DIMENSION	100 p.	P
123 510	Crème	25x16	135,4	25 m
123 530	Marron	25x16	135,4	25 m
123 550	Noir	25x16	135,4	25 m

Cotes en mm

## Rail composite à encastrer Pour haut et bas - s'assemble avec références 111320 & 111340. Longueur 2m



REF.	DIMENSION	P
111 300	12x7	20

Cotes en mm

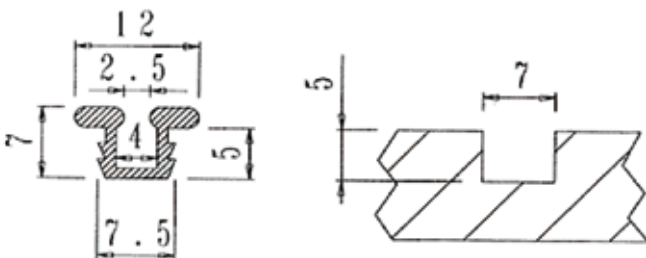

## 12.1 ACCESSOIRES PORTES COULISSANTES

### 1810 | Poignée cuvette plastique à encastrer

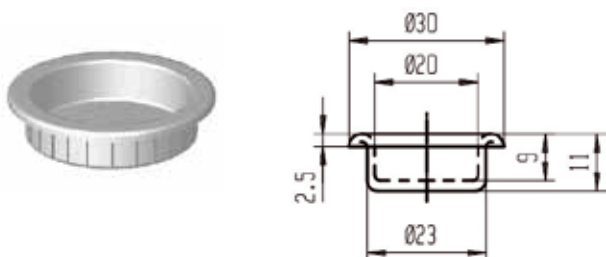

REF.	FINITION	Kg 100 p.	
131 010	Blanc	0,28	50
131 050	Noir	0,28	50

Cotes en mm

### 1812 | Poignée cuvette plastique à encastrer

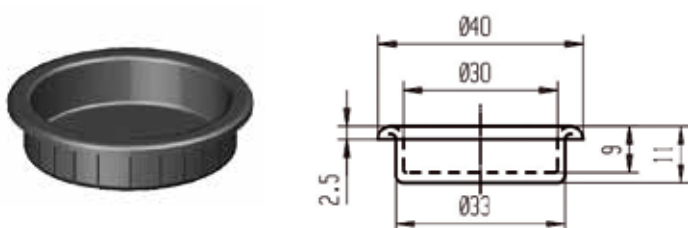

REF.	FINITION	Kg 100 p.	
131 210	Blanc	0,42	50
131 250	Noir	0,42	50

Cotes en mm

### 1814 | Poignée cuvette plastique à encastrer

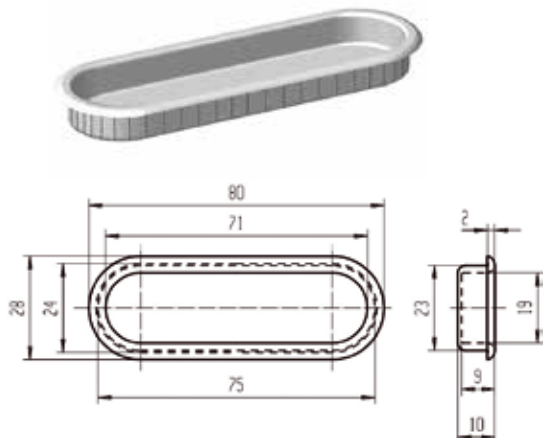

REF.	FINITION	Kg 100 p.	
131 610	Blanc	0,6	50
131 650	Noir	0,6	50

Cotes en mm

### 1816 | Poignée cuvette à encastrer

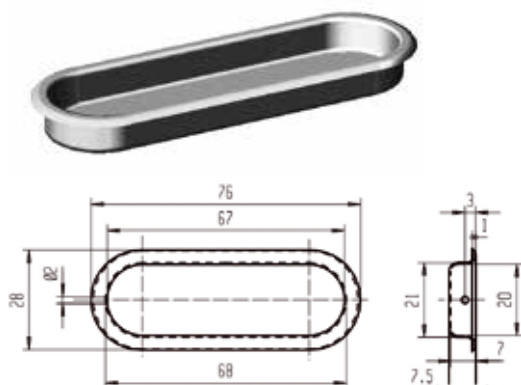

REF.	FINITION	Kg 100 p.	
131 810	Acier inoxydable	1	50
131 850	Laiton poli	1	50

Cotes en mm

## 12.2 AMÉNAGEMENT DE PLACARDS

### I Support pour tube de penderie double vissage A.L. Hauteur 72 mm



REF.	Kg 100 p.	P
523 210	2,05	20

Cotes en mm

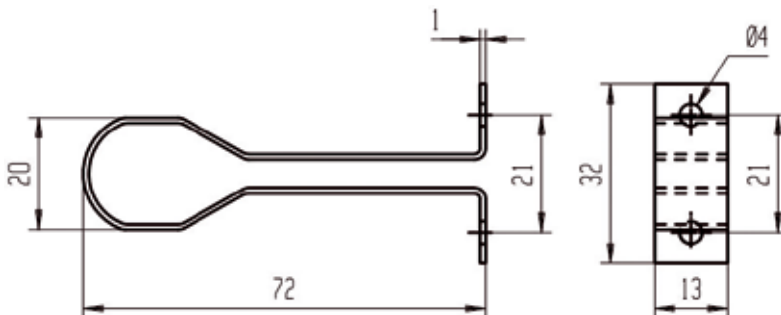

## 12.3 PATINS ET EMBOUTS

### I Patin adhésif feutre MARRON



Epaisseur = 3



REF.	DESIGNATION	A	Kg 100 p.	P
311 031	1 unité : 12 patins Ø 22 mm	22	1,96	10
311 051	1 unité : 8 patins Ø 25 mm	25	1,98	10
311 071	1 unité : 6 patins Ø 28 mm	28	1,92	10
311 091	1 unité : 6 patins Ø 33 mm	33	2,03	10

Cotes en mm

## 12.3 PATINS ET EMBOUTS

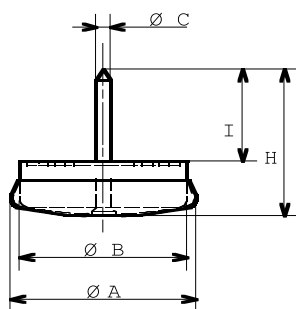
### I Patin à pointer A.N.





REF.	A	B	C	H	I	 Kg 100 p.	 P
315 330	18	15,5	2	23	14	5,5	20
315 350	25	19,5	2	30	20	9,1	20
315 370	30	25	2	30	21	14,6	20
315 390	40	36	2,7	35	22	23,9	20

Cotes en mm

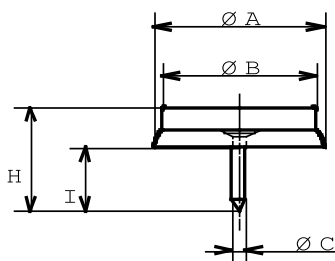
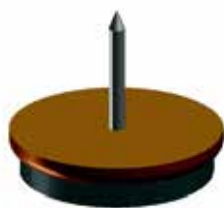
### I Patin à pointer plastique marron / feutre marron





REF.	A	B	C	H	I	 Kg 100 p.	 P
315 610	18	17	2	25	15	3,3	20
315 630	24	20	2	24	15	3,9	20
315 650	28	28	2	23,5	13	7,3	20

Cotes en mm

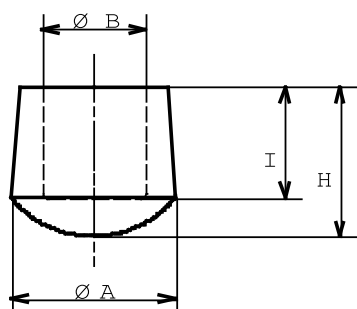
### I Embout coiffant caoutchouc noir





REF.	A	B	H	I	 Kg 100 p.	 P
322 110	29	20	32	23	1,84	20
322 130	31	22	30	22	2,67	20
322 150	35	26	34	23	3,37	20

Cotes en mm

## 12.4 AUTRES

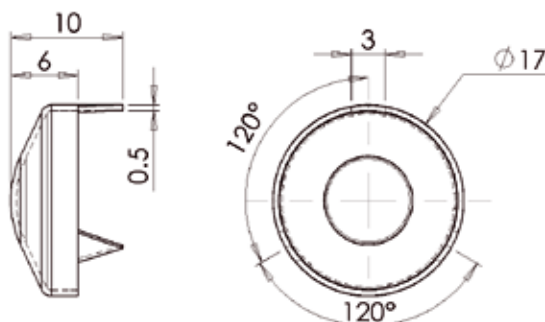
### I 7541 | Cache écrou 3 pointes





REF.	FINITION	 Kg 100 p.	 P
791 010	Acier nickelé	0,14	200
791 030	Acier laitonné	0,14	200

Cotes en mm

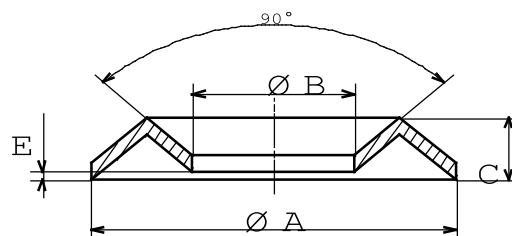
### I 7549 | Cuvette à vis laiton nickelé



REF.	A	B	C	E	 Kg 100 p.	 P
791 090	9	4	1,5	0,3	0,2	250
791 110	11	5	2	0,5	0,25	250
791 130	13	6	2,3	0,5	0,3	250
791 150	15	7	2,5	1	0,6	250
791 170	18	8	3	1,5	0,9	250

Cotes en mm

### I Porte étiquette





REF.	FINITION	 Kg 100 p.	 P
591 610	Couleurs assorties	3,1	100

Cotes en mm

# 13.1 CRÉMAILLÈRES ET CONSOLES

## Crémaillère simple entraxe 50





REF.	DÉSIGNATION	AxB	 Kg 100 p.	
0913326	Crémaillère simple L500 Blanc	500x50	25	12
0912526	Crémaillère simple L1000 Blanc	1000x50	40	12
0912926	Crémaillère simple L1500 Blanc	1500x50	60	12
0913226	Crémaillère simple L2000 Blanc	2000x50	81	12
0913316	Crémaillère simple L500 Gris	500x50	25	12
0912516	Crémaillère simple L1000 Gris	1000x50	40	12
0912916	Crémaillère simple L1500 Gris	1500x50	60	12
0913216	Crémaillère simple L2000 Gris	2000x50	81	12

Cotes en mm

## Console simple entraxe 50





REF.	DÉSIGNATION	AxB	 Kg 100 p.	
1078626	Console simple L150 Blanc	150x50	5,8	10
1078726	Console simple L200 Blanc	200x50	8	10
1078826	Console simple L250 Blanc	250x50	11	10
1078926	Console simple L300 Blanc	300x50	13	10
1079026	Console simple L350 Blanc	350x50	17	10
1079126	Console simple L400 Blanc	400x50	20	10
1079226	Console simple L500 Blanc	500x50	45,5	10
1080116	Console simple L150 Gris	150x50	5,8	10
1080216	Console simple L200 Gris	200x50	8	10
1080316	Console simple L250 Gris	250x50	11	10
1080416	Console simple L300 Gris	300x50	13	10
1080516	Console simple L350 Gris	350x50	17	10
1080616	Console simple L400 Gris	400x50	20	10
1080716	Console simple L500 Gris	500x50	45,5	10

Cotes en mm



## Crémaillère double entraxe 32





REF.	DÉSIGNATION	AxB	 100 p.	
0972426	Crémaillère double L1000 Blanc	1000x32	61	10
0972526	Crémaillère double L1500 Blanc	1500x32	70	10
0969226	Crémaillère double L2000 Blanc	2000x32	95	10
0972616	Crémaillère double L1000 Gris	1000x32	61	10
0972716	Crémaillère double L1500 Gris	1500x32	90	10
0972916	Crémaillère double L2000 Gris	2000x32	95	10

Cotes en mm

## Console double entraxe 32





REF.	DÉSIGNATION	AxB	 100 p.	
0971326	Console double L120 Blanc	120x32	6,3	10
0971426	Console double L170 Blanc	170x32	8,3	10
0971526	Console double L220 Blanc	220x32	16	10
0968926	Console double L270 Blanc	270x32	20	10
0969026	Console double L320 Blanc	320x32	24,5	10
0969126	Console double L370 Blanc	370x32	30	10
0971626	Console double L470 Blanc	470x32	45	10
0971716	Console double L120 Gris	120x32	6,3	10
0971816	Console double L170 Gris	170x32	8,3	10
0971916	Console double L220 Gris	220x32	16	10
0972016	Console double L270 Gris	270x32	22	10
0972116	Console double L320 Gris	320x32	27	10
0972216	Console double L370 Gris	370x32	33	10
0972316	Console double L470 Gris	470x32	45	10

Cotes en mm

# 13.1 CRÉMAILLÈRES ET CONSOLES

## Crémaillère double entraxe 50





REF.	DÉSIGNATION	AxB	 Kg 100 p.	
0930126	Crémaillère double L470 Blanc	470x50	31	10
0912326	Crémaillère double L950 Blanc	950x50	50	10
0910326	Crémaillère double L1400 Blanc	1400x50	70	10
0910626	Crémaillère double L2060 Blanc	2060x50	105	10
0911826	Crémaillère double L2290 Blanc	2290x50	115	10
0930116	Crémaillère double L470 Gris	470x50	31	10
0930216	Crémaillère double L950 Gris	950x50	50	10
0930316	Crémaillère double L1400 Gris	1400x50	90	10
0930716	Crémaillère double L2060 Gris	2060x50	105	10
0930816	Crémaillère double L2300 Gris	2300x50	115	10

Cotes en mm

## Console double entraxe 50





REF.	DÉSIGNATION	AxB	 Kg 100 p.	
1079326	Console double L120 Blanc	120x50	6	10
1079426	Console double L170 Blanc	170x50	8	10
1079526	Console double L220 Blanc	220x50	14	10
1079626	Console double L270 Blanc	270x50	20	10
1079726	Console double L320 Blanc	320x50	24,5	10
1079826	Console double L370 Blanc	370x50	30	10
1079926	Console double L470 Blanc	470x50	43	10
1080816	Console double L120 Gris	120x50	6	10
1080916	Console double L170 Gris	170x50	8	10
1081016	Console double L220 Gris	220x50	14	10
1081116	Console double L270 Gris	270x50	20	10
1081216	Console double L320 Gris	320x50	24,5	10
1081316	Console double L370 Gris	370x50	30	10
1081416	Console double L470 Gris	470x50	43	10

Cotes en mm

## 13.2 ACCESSOIRES CRÉMAILLÈRES ET CONSOLES

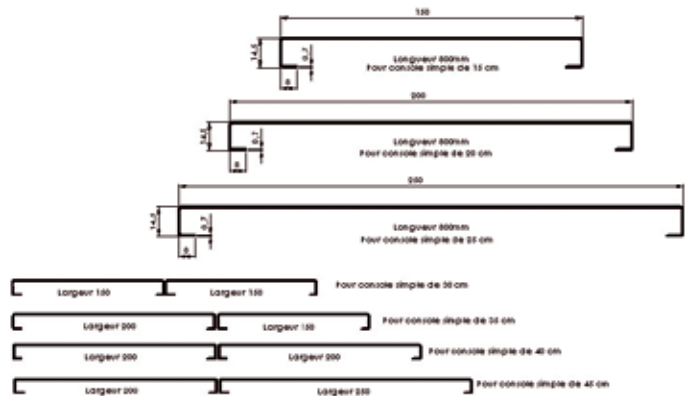
### 8302 | Tablette métallique juxtaposable pour console simple pour console simple de 15 cm à 45 cm





REF.	DÉSIGNATION	AxB	 Kg 100 p.	 P
527 000	Tablette pour console de 150 Gris	800x150	83	10
527 010	Tablette pour console de 150 Blanc	800x150	83	10
527 020	Tablette pour console de 150 Noir	800x150	83	10
527 030	Tablette pour console de 200 Gris	800x200	105	10
527 040	Tablette pour console de 200 Blanc	800x200	105	10
527 050	Tablette pour console de 200 Noir	800x200	105	10
527 060	Tablette pour console de 250 Gris	800x250	127	10
527 070	Tablette pour console de 250 Blanc	800x250	127	10
527 080	Tablette pour console de 250 Noir	800x250	127	10

Cotes en mm

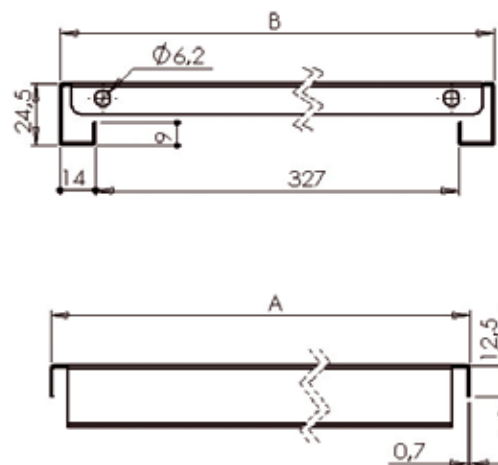
### 8303 | Tablette métallique dossier suspendu pour console simple de 35 cm



REF.	DÉSIGNATION	AxB	 Kg 100 p.	 P
527 090	Tablette dossier suspendu Gris	800x360	197	10
527 100	Tablette dossier suspendu Blanc	800x360	197	10
527 110	Tablette dossier suspendu Noir	800x360	197	10

Cotes en mm

# 13.2 ACCESSOIRES CRÉMAILLÈRES ET CONSOLES

## 8300 | Support de rayon économique Sachet de 12 supports

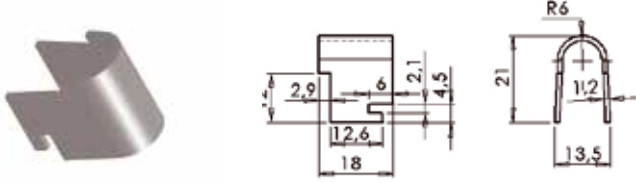

REF.	DÉSIGNATION	AxB	100 p.	
530 040	Support de rayon économique	21x18	8,4	Sachet de 12

Cotes en mm

## 8330 | Tasseau de pose Sachet de 6 tasseaux + 6 vis + 6 chevilles

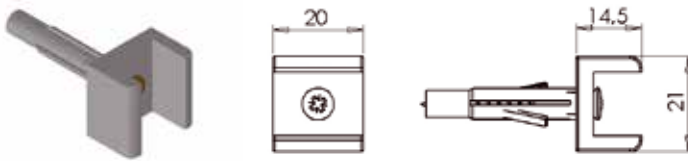

REF.	DÉSIGNATION	AxB	mm	100 p.	
530 000	Tasseau de pose pour crémaillère double	21x20	4x45	3,6	Sachet de 6

Cotes en mm

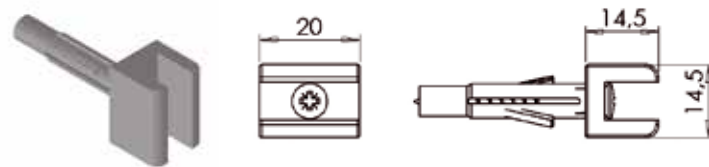

REF.	DÉSIGNATION	AxB	mm	100 p.	
530 010	Tasseau de pose pour crémaillère simple	14,5x20	4x45	3	Sachet de 6

Cotes en mm

## 8331 | Support pour tablette Sachet de 12 supports

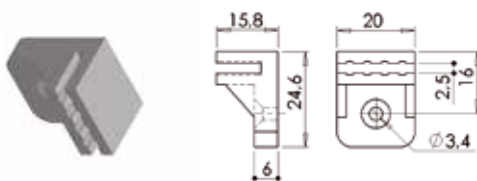

REF.	DÉSIGNATION	AxB	mm	100 p.	
530 020	Support pour tablette	25x20	3	4,3	Sachet de 12

Cotes en mm / assure la liaison entre la tablette métallique ou bois sur consoles simples

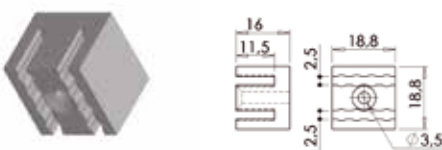

REF.	DÉSIGNATION	AxB	mm	100 p.	
530 030	Adaptateur double console	19x19	3	5	Sachet de 12

Cotes en mm / assure la liaison entre la tablette métallique ou bois sur consoles doubles

## 14.1 KITS ÉTAGÈRES

### 8830 | Kit Clip-Top 600Kg Liaisons par emboîtement / 5 plateaux, charge utile / plateau : 120Kg uniformément répartis



REF.	DÉSIGNATION	HxLxP	
540 000	Kit Clip-Top Blanc	2000x800x400	1
540 010	Kit Clip-Top Noir	2000x800x400	1

Cotes en mm

### 8830 | Kit Clip-Top Suite 600Kg Liaisons par emboîtement / 5 plateaux, charge utile / plateau : 120Kg uniformément répartis



REF.	DÉSIGNATION	HxLxP	
540 020	Kit Clip-Top complément Blanc	2000x800x400	1
540 030	Kit Clip-Top complément Noir	2000x800x400	1

Cotes en mm

### 8831 | Kit Pro 600 à 900 Kg Liaisons boulonnées Charge utile / plateau: 150Kg uniformément répartis cornières nervurées 40x40 épaisseur 2

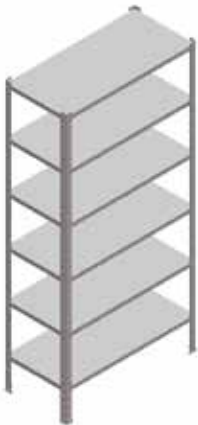

REF.	DÉSIGNATION	HxLxP	
540 040	Kit Clip-Top 4 plateaux Blanc	2000x960x450	1
540 050	Kit Clip-Top 4 plateaux Noir	2000x960x450	1
540 060	Kit Clip-Top 4 plateaux Vert	2000x960x450	1
540 070	Kit Clip-Top 5 plateaux Blanc	2000x960x450	1
540 080	Kit Clip-Top 5 plateaux Noir	2000x960x450	1
540 090	Kit Clip-Top 5 plateaux Vert	2000x960x450	1
540 100	Kit Clip-Top 6 plateaux Blanc	2000x960x450	1
540 110	Kit Clip-Top 6 plateaux Noir	2000x960x450	1
540 120	Kit Clip-Top 6 plateaux Vert	2000x960x450	1

Cotes en mm

### 8832 | Kit Clip-Clac 1000 Kg Liaisons par emboîtement / 4 plateaux bois épaisseur 16mm / charge utile / plateau: 250 Kg uniformément répartis / cornières nervurées 40x40 épaisseur 2



REF.	DÉSIGNATION	HxLxP	
540 130	Kit Clip-Clac Blanc	2000x960x450	1
540 140	Kit Clip-Clac Noir	2000x960x450	1
540 150	Kit Clip-Clac Vert	2000x960x450	1

Cotes en mm

## 14.1 KITS ÉTAGÈRES

### 8833 | Kit Brico 200 Kg Liaisons boulonnées / Charge utile / plateau: 50 Kg uniformément répartis cornière lisse 27x27 épaisseur 1,5

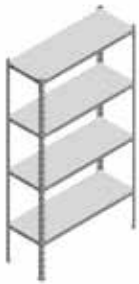

REF.	DÉSIGNATION	HxLxP	
540 160	Kit Brico 4 plateaux Blanc	1500x800x300	1
540 170	Kit Brico 4 plateaux Gris	1500x800x300	1
540 180	Kit Brico 4 plateaux Galva	1500x800x300	1
540 190	Kit Brico 4 plateaux Noir	1500x800x300	1

Cotes en mm

### 8833 | Kit Brico 350 Kg Liaisons boulonnées / Charge utile / plateau: 70 Kg uniformément répartis cornière lisse 27x27 épaisseur 1,5

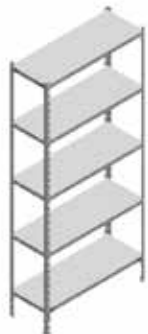

REF.	DÉSIGNATION	HxLxP	
540 200	Kit Brico 5 plateaux Blanc	1800x800x300	1
540 210	Kit Brico 5 plateaux Gris	1800x800x300	1
540 220	Kit Brico 5 plateaux Galva	1800x800x300	1
540 230	Kit Brico 5 plateaux Noir	1800x800x300	1
540 240	Kit Brico 5 plateaux Blanc	1800x800x400	1
540 250	Kit Brico 5 plateaux Gris	1800x800x400	1
540 260	Kit Brico 5 plateaux Galva	1800x800x400	1
540 270	Kit Brico 5 plateaux Noir	1800x800x400	1

Cotes en mm

### 8833 | Kit Brico 500 Kg Liaisons boulonnées / Charge utile / plateau: 100 Kg uniformément répartis cornière lisse 27x27 épaisseur 1,5

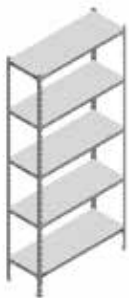

REF.	DÉSIGNATION	HxLxP	
540 280	Kit Brico 5 plateaux Blanc	2000x1000x300	1
540 290	Kit Brico 5 plateaux Gris	2000x1000x300	1
540 300	Kit Brico 5 plateaux Galva	2000x1000x300	1
540 310	Kit Brico 5 plateaux Noir	2000x1000x300	1

Cotes en mm

### 8833 | Kit Brico 600 Kg Liaisons boulonnées / Charge utile / plateau: 120 Kg uniformément répartis cornière lisse 38x38 épaisseur 1,5



REF.	DÉSIGNATION	HxLxP	
540 320	Kit Brico 5 plateaux Blanc	2000x1000x400	1
540 330	Kit Brico 5 plateaux Gris	2000x1000x400	1
540 340	Kit Brico 5 plateaux Galva	2000x1000x400	1
540 350	Kit Brico 5 plateaux Noir	2000x1000x400	1
540 360	Kit Brico 5 plateaux Blanc	2000x1000x500	1
540 370	Kit Brico 5 plateaux Gris	2000x1000x500	1
540 380	Kit Brico 5 plateaux Galva	2000x1000x500	1
540 390	Kit Brico 5 plateaux Noir	2000x1000x500	1

Cotes en mm

**8833 | Kit Brico 250 Kg** Pour angle / liaisons boulonnées / Charge utile / plateau: 50 Kg uniformément répartis  
cornière lisse 27x27 épaisseur 1,5



REF.	DÉSIGNATION	HxLxP	
540 400	Kit Brico 5 plateaux Blanc	1800x400x300	1
540 410	Kit Brico 5 plateaux Gris	1800x400x300	1
540 420	Kit Brico 5 plateaux Galva	1800x400x300	1
540 430	Kit Brico 5 plateaux Noir	1800x400x300	1

Cotes en mm

**8834 | Kit Modulo 250 Kg** Pour angle / liaisons boulonnées / Charge utile / plateau: 50 Kg uniformément répartis  
cornière lisse 27x27 épaisseur 1,5

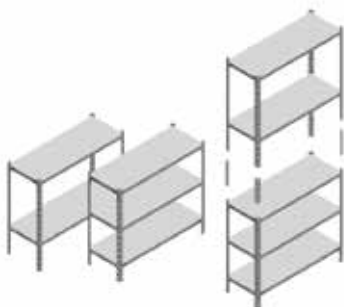

REF.	DÉSIGNATION	HxLxP	
540 440	Kit Modulo 5 plateaux Blanc	(2x750)x800x300	1
540 450	Kit Modulo 5 plateaux Gris	(2x750)x800x300	1
540 460	Kit Modulo 5 plateaux Galva	(2x750)x800x300	1
540 470	Kit Modulo 5 plateaux Noir	(2x750)x800x300	1
540 480	Kit Modulo 5 plateaux Blanc	(2x900)x800x300	1
540 490	Kit Modulo 5 plateaux Gris	(2x900)x800x300	1
540 500	Kit Modulo 5 plateaux Galva	(2x900)x800x300	1
540 510	Kit Modulo 5 plateaux Noir	(2x900)x800x300	1

Cotes en mm

**8834 | Kit Modulo 300 Kg** Pour angle / liaisons boulonnées / Charge utile / plateau: 50 Kg uniformément répartis  
cornière lisse 27x27 épaisseur 1,5

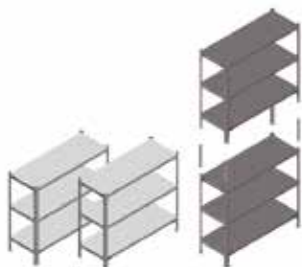

REF.	DÉSIGNATION	HxLxP	
540 520	Kit Modulo 6 plateaux Blanc	(2x900)x800x300	1
540 530	Kit Modulo 6 plateaux Gris	(2x900)x800x300	1
540 540	Kit Modulo 6 plateaux Galva	(2x900)x800x300	1
540 550	Kit Modulo 6 plateaux Noir	(2x900)x800x300	1

Cotes en mm

**8834 | Kit Modulo 480 Kg** Pour angle / liaisons boulonnées / Charge utile / plateau: 120 Kg uniformément répartis  
cornière lisse 38x38 épaisseur 1,5

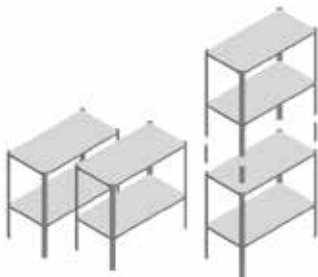

REF.	DÉSIGNATION	HxLxP	
540 560	Kit Modulo 4 plateaux Blanc	(2x1000)x1000x500	1
540 570	Kit Modulo 4 plateaux Gris	(2x1000)x1000x500	1
540 580	Kit Modulo 4 plateaux Galva	(2x1000)x1000x500	1
540 590	Kit Modulo 4 plateaux Noir	(2x1000)x1000x500	1

Cotes en mm

**8834 | Kit Modulo 250 Kg** Pour angle / liaisons boulonnées / Charge utile / plateau: 50 Kg uniformément répartis  
cornière lisse 27x27 épaisseur 1,5

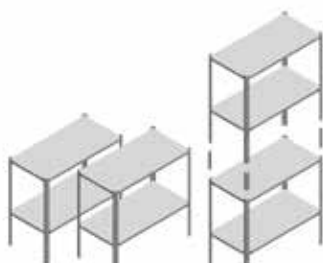



REF.	DÉSIGNATION	HxLxP	
540 600	Kit Modulo 5 plateaux Blanc	(2x900)x400x300	1
540 610	Kit Modulo 5 plateaux Gris	(2x900)x400x300	1
540 620	Kit Modulo 5 plateaux Galva	(2x900)x400x300	1
540 630	Kit Modulo 5 plateaux Noir	(2x900)x400x300	1

Cotes en mm

## 14.2 ACCESSOIRES CORNIÈRES

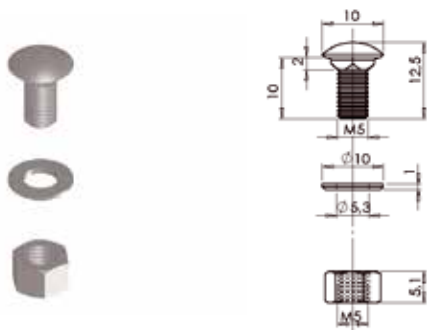
### 8819 | Boulon M5 A.Z. Sachet de vis M5x16, rondelles M5 et écrous M5, pour cornière nervurée 30x30



REF.	Kg 100 p.	
539 590	11	Sachet de 25
539 600	22	Sachet de 50

Cotes en mm

### 8819 | Boulon M6 A.Z. Sachet de vis M6x16 / rondelles M6 et écrous M6 / pour cornière nervurée 40x40

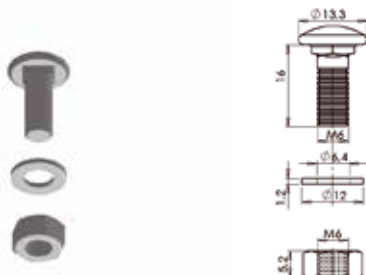

REF.	Kg 100 p.	
538 630	24	Sachet de 25
538 640	48	Sachet de 50

Cotes en mm

### 8819 | Boulon M8 A.Z Sachet de vis M8x20, rondelles M8 et écrous M8, pour cornière nervurée 50x50

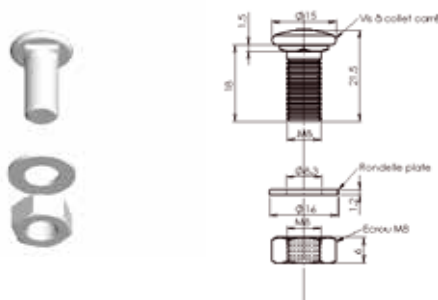

REF.	Kg 100 p.	
538 830	38,3	Sachet de 25
538 840	76,6	Sachet de 50

Cotes en mm

### 8819 | Taquet d'angle A.Z pour plateau pour cornière nervurée 40x40

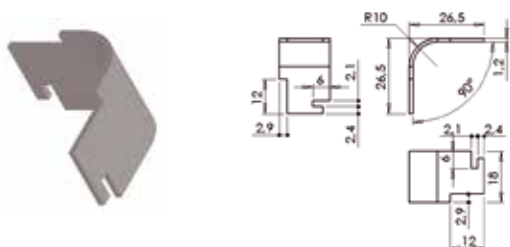

REF.	Kg 100 p.	
538 660	17,5	Sachet de 25

Cotes en mm

### 8819 | Plaquette de liaison A.Z. Pour cornière nervurée 30x30

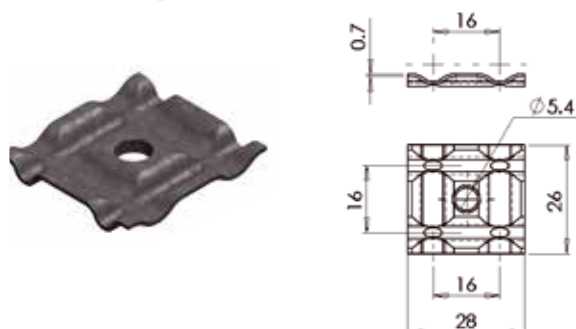



REF.	Kg 100 p.	
539 610	12	Sachet de 25
539 620	24	Sachet de 50

Cotes en mm

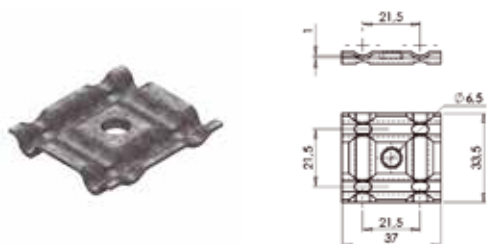

## 8819 | Plaquette de liaison A.Z. pour cornière nervurée 40x40



REF.	Kg 100 p.	
538 650	30	Sachet de 25

Cotes en mm

## 8819 | Plaquette de liaison A.Z. Pour cornière de 50x50

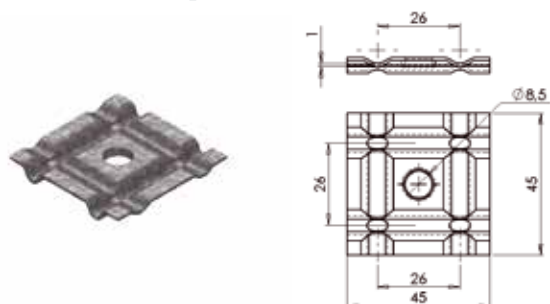

REF.	Kg 100 p.	
538 810	45	Sachet de 25
538 820	90	Sachet de 50

Cotes en mm

## 8829 | Gousset de renfort Epaisseur 0,9 mm

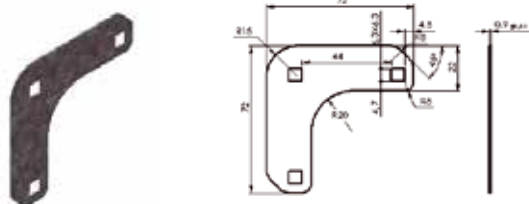

REF.	FINITION	Kg 100 p.	
539 460	Galva	44,5	Sachet de 25
539 470	Blanc	44,5	Sachet de 25
539 480	Noir	44,5	Sachet de 25
539 490	Gris	44,5	Sachet de 25

Cotes en mm

## 8819 | Equerre support cadmié Pour cornière nervurée 30x30

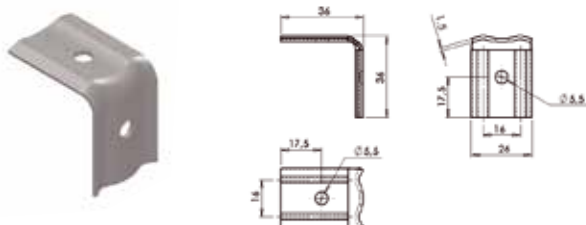

REF.	Kg 100 p.	
539 630	1,9	1

Cotes en mm

## 8819 | Equerre support cadmié pour cornière nervurée 40x40

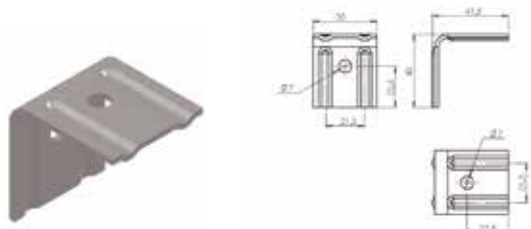



REF.	Kg 100 p.	
538 710	4,2	1

Cotes en mm

## 14.2 ACCESSOIRES CORNIÈRES

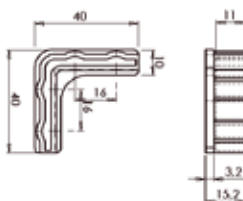
### 8829 | Pied plastique simple Pour cornière lisse de 27x27



REF.	Kg 100 p.	
539 640	2,1	Sachet de 4

Cotes en mm

### 8819 | Pied plastique simple pour cornière nervurée 40x40

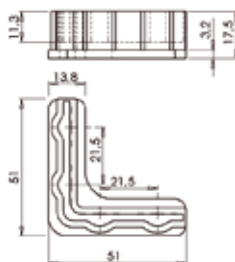

REF.	Kg 100 p.	
538 670	4	Sachet de 4
538 690	1	Sachet de 1

Cotes en mm

### 8819 | Pied plastique double pour cornière nervurée 40x40

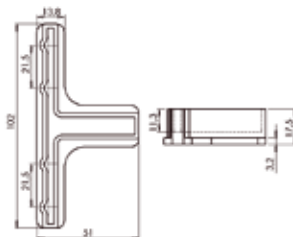

REF.	Kg 100 p.	
538 680	6,4	Sachet de 4
538 700	1,6	Sachet de 1

Cotes en mm

### 8819 | Embase métallique A.Z Pour cornière de 50x50

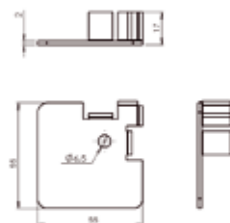

REF.	Kg 100 p.	
538 850	5,3	1

Cotes en mm

### 8829 | Pied plastique simple Pour cornière lisse de 27x27

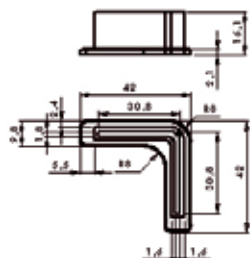

REF.	Kg 100 p.	
539 500	0,4	Sachet de 1
539 510	1,6	Sachet de 4

Cotes en mm

### 8829 | Pied plastique simple Pour cornière lisse de 38x38

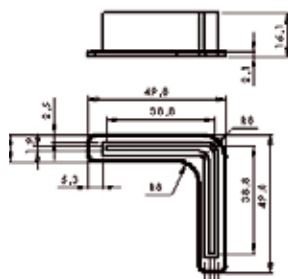
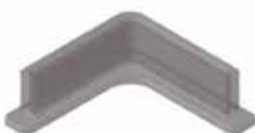



REF.	Kg 100 p.	
539 520	0,5	Sachet de 1
539 530	2	Sachet de 4

Cotes en mm

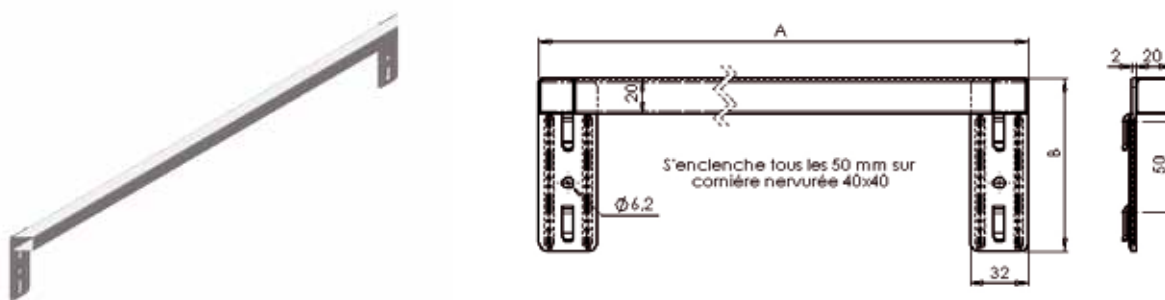
## 8811 | Traverse Clic Clac Pour cornière nervurée de 40x40





REF.	DÉSIGNATION	AxB	 Kg 100 p.	
538 000	Traverse Clic Clac lg 350 Vert	340x95	28,5	Lot de 10
538 010	Traverse Clic Clac lg 350 Blanc	340x95	28,5	Lot de 10
538 020	Traverse Clic Clac lg 350 Noir	340x95	28,5	Lot de 10
538 030	Traverse Clic Clac lg 450 Vert	440x95	34	Lot de 10
538 040	Traverse Clic Clac lg 450 Blanc	440x95	34	Lot de 10
538 050	Traverse Clic Clac lg 450 Noir	440x95	34	Lot de 10
538 060	Traverse Clic Clac lg 550 Vert	540x95	40	Lot de 10
538 070	Traverse Clic Clac lg 550 Blanc	540x95	40	Lot de 10
538 080	Traverse Clic Clac lg 550 Noir	540x95	40	Lot de 10
538 090	Traverse Clic Clac lg 650 Vert	640x95	45,5	Lot de 10
538 100	Traverse Clic Clac lg 650 Blanc	640x95	45,5	Lot de 10
538 110	Traverse Clic Clac lg 650 Noir	640x95	45,5	Lot de 10
538 120	Traverse Clic Clac lg 750 Vert	740x95	51,3	Lot de 10
538 130	Traverse Clic Clac lg 750 Blanc	740x95	51,3	Lot de 10
538 140	Traverse Clic Clac lg 750 Noir	740x95	51,3	Lot de 10
538 150	Traverse Clic Clac lg 960 Vert	950x95	63,5	Lot de 10
538 160	Traverse Clic Clac lg 960 Blanc	950x95	63,5	Lot de 10
538 170	Traverse Clic Clac lg 960 Noir	950x95	63,5	Lot de 10

Cotes en mm

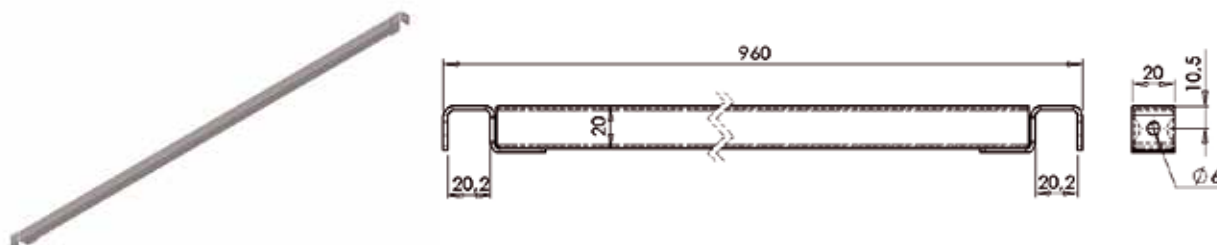
## 8813 | Barreau enclenchable Pour cornière nervurée de 40x40





REF.	DÉSIGNATION	AxB	 Kg 100 p.	
538 180	Barreau enclenchable lg 960 Vert	960x20	57	Lot de 10
538 190	Barreau enclenchable lg 960 Blanc	960x20	57	Lot de 10
538 200	Barreau enclenchable lg 960 Noir	960x20	57	Lot de 10

Cotes en mm

## 14.3 ACCESSOIRES CORNIÈRES

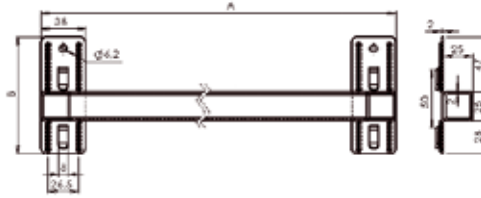
### 8811 | Traverse Clic Clac Pour cornière nervurée de 50X50





REF.	DÉSIGNATION	AxB	 Kg 100 p.	
538 760	Traverse Clic Clac lg 500 Vert	485x100	79	10
538 770	Traverse Clic Clac lg 750 Vert	735x100	114	10
538 780	Traverse Clic Clac lg 1000 Vert	985x100	148,5	10
538 790	Traverse Clic Clac lg 1500 Vert	1485x100	218	10
538 800	Traverse Clic Clac lg 2000 Vert	1985x100	288	10

Cotes en mm

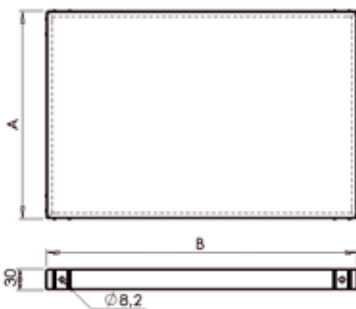
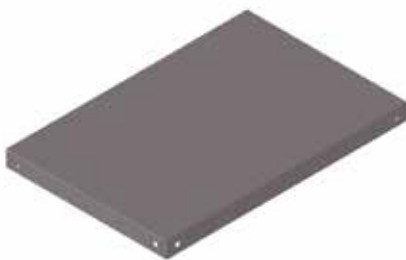
### 8810 | Plateau métallique renforcé Charge 150Kg uniformément répartis Épaisseur 0,9 mm pour cornière nervurée 40x40





REF.	DÉSIGNATION	AxB	 Kg 100 p.	
538 360	Plateau métallique 300x450 Vert	300x450	13	6
538 370	Plateau métallique 300x450 Blanc	300x450	13	6
538 380	Plateau métallique 300x450 Noir	300x450	13	6
538 390	Plateau métallique 350x450 Vert	350x450	15	6
538 400	Plateau métallique 350x450 Blanc	350x450	15	6
538 410	Plateau métallique 350x450 Noir	350x450	15	6
538 420	Plateau métallique 450x450 Vert	450x450	19	6
538 430	Plateau métallique 450x450 Blanc	450x450	19	6
538 440	Plateau métallique 450x450 Noir	450x450	19	6
538 450	Plateau métallique 300x960 Vert	300x960	26	6
538 460	Plateau métallique 300x960 Blanc	300x960	26	6
538 470	Plateau métallique 300x960 Noir	300x960	26	6
538 480	Plateau métallique 350x960 Vert	350x960	30	6
538 490	Plateau métallique 350x960 Blanc	350x960	30	6
538 500	Plateau métallique 350x960 Noir	350x960	30	6
538 510	Plateau métallique 450x960 Vert	450x960	37	6
538 520	Plateau métallique 450x960 Blanc	450x960	37	6
538 530	Plateau métallique 450x960 Noir	450x960	37	6

Cotes en mm

## 8815 | Plateau métallique renforcé Charge 250Kg uniformément répartis

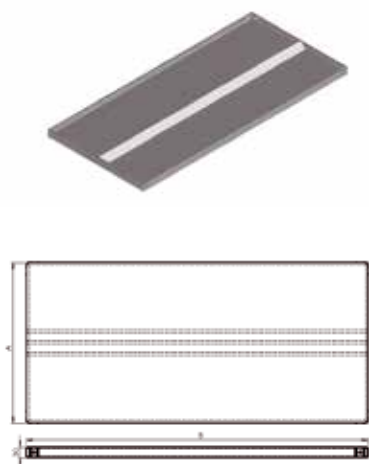
Epaisseur 0,9 mm pour cornière nervurée 40x40



REF.	DÉSIGNATION	AxB	Kg 100 p.	
538 540	Plateau métallique 450x960 Vert	450x960	43	6
538 550	Plateau métallique 450x960 Blanc	450x960	43	6
538 560	Plateau métallique 450x960 Noir	450x960	43	6
538 570	Plateau métallique 550x960 Vert	550x960	51	6
538 580	Plateau métallique 550x960 Blanc	550x960	51	6
538 590	Plateau métallique 550x960 Noir	550x960	51	6
538 600	Plateau métallique 750x960 Vert	750x960	66	6
538 610	Plateau métallique 750x960 Blanc	750x960	66	6
538 620	Plateau métallique 750x960 Noir	750x960	66	6

Cotes en mm

## 8820 | Plateau métallique charge 120Kg uniformément répartis

Epaisseur 0,7 mm pour cornière lisse de 27x27 et 38x38 réf: 538120 à 538350

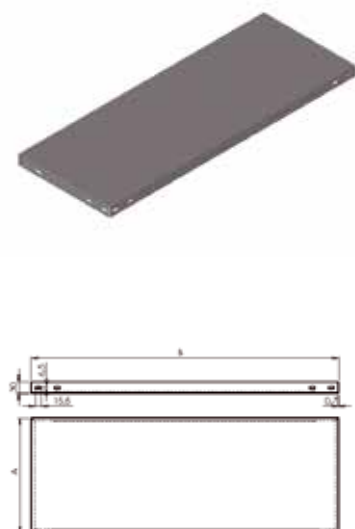

REF.	DÉSIGNATION	AxB	Kg 100 p.	
539 260	Plateau métallique 300x800 Galva	300x800	177	5
539 270	Plateau métallique 300x800 Blanc	300x800	177	5
539 280	Plateau métallique 300x800 Noir	300x800	177	5
539 290	Plateau métallique 300x800 Gris	300x800	177	5
539 300	Plateau métallique 400x800 Galva	400x800	224,5	5
539 310	Plateau métallique 400x800 Blanc	400x800	224,5	5
539 320	Plateau métallique 400x800 Noir	400x800	224,5	5
539 330	Plateau métallique 400x800 Gris	400x800	224,5	5
539 340	Plateau métallique 300x1000 Galva	300x1000	218,5	5
539 350	Plateau métallique 300x1000 Blanc	300x1000	218,5	5
539 360	Plateau métallique 300x1000 Noir	300x1000	218,5	5
539 370	Plateau métallique 300x1000 Gris	300x1000	218,5	5
539 380	Plateau métallique 400x1000 Galva	400x1000	277	5
539 390	Plateau métallique 400x1000 Blanc	400x1000	277	5
539 400	Plateau métallique 400x1000 Noir	400x1000	277	5
539 410	Plateau métallique 400x1000 Gris	400x1000	277	5
539 420	Plateau métallique 500x1000 Galva	500x1000	335,5	5
539 430	Plateau métallique 500x1000 Blanc	500x1000	335,5	5
539 440	Plateau métallique 500x1000 Noir	500x1000	335,5	5
539 450	Plateau métallique 500x1000 Gris	500x1000	335,5	5

Cotes en mm

