



Articulations de portails



Caractéristiques



Faure et Fils® vous propose toute une gamme d'articulation de portails.

Le choix important de modèles ainsi que leurs possibilités de réglages leurs permettent de s'adapter à tous types de poses.

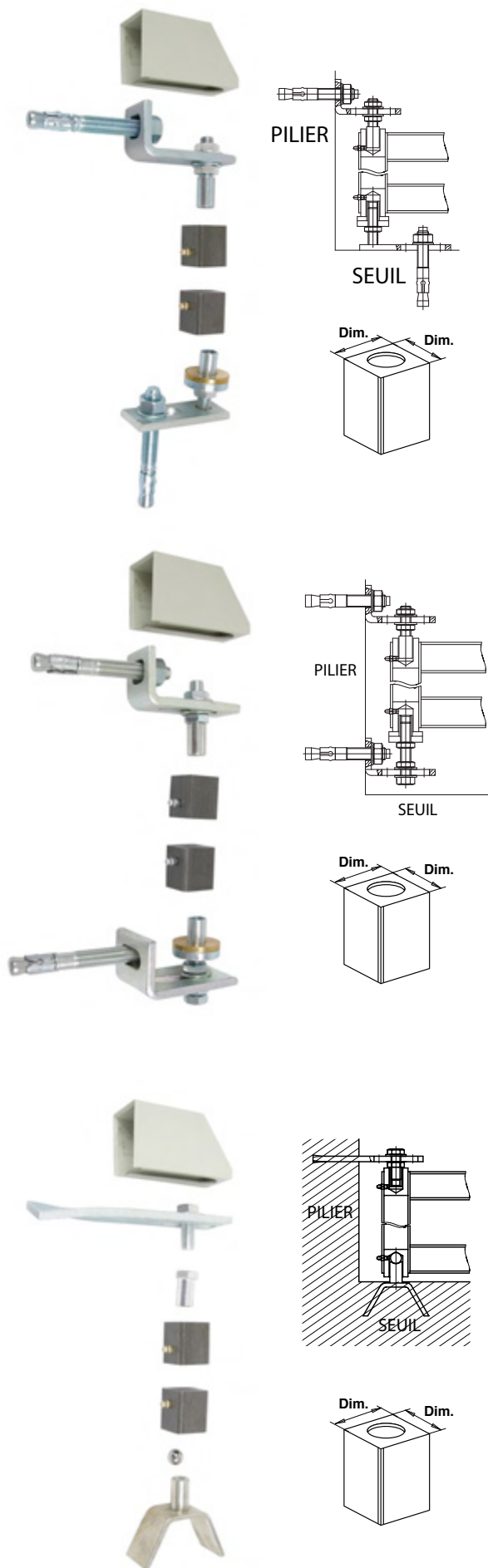

Disponibles pour portails bois ou métalliques.





PIVOT1.. Pivot 100 à cheviller

Code		Dim.	Charge max /vantail	Tarif HT en €		Cat.
PIEM1040	BRUT	40x40	150 kg	88,71	1	2
PIVOT150	BRUT	50x50	150 kg	100,73	1	2

PIEM30.. Pivot 300 à cheviller

Code		Dim.	Charge max /vantail	Tarif HT en €		Cat.
PIEM3040	BRUT	40x40	150 kg	94,83	1	2
PIEM3050	BRUT	50x50	150 kg	110,27	1	2

PIEM40.. Pivot 400 à sceller

Code		Dim.	Charge max /vantail	Tarif HT en €		Cat.
PIEM4040	BRUT	40x40	150 kg	75,33	1	2
PIEM4050	BRUT	50x50	150 kg	86,71	1	2

Ferrures pour portails bois

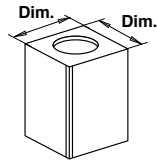
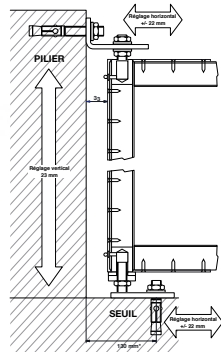

PIVOT500 Pivot 500

Code		Dim.	Charge max /vantail	Tarif HT en €		Cat.
PIVOT500	BRUT	40x40	150 kg	125,37	1	4

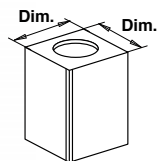
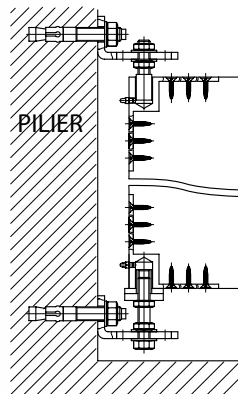

PIVOT510 Pivot 510

Code		Dim.	Charge max /vantail	Tarif HT en €		Cat.
PIVOT510	BRUT	40x40	150 kg	118,28	1	4

Ferrures pour portails bois

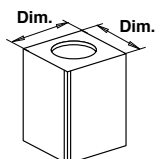

PIVOT8.. Pivot 800 avec chevilles

Code		Dim.	Tarif HT en €		Cat.
PIVOT840	BRUT	40x40	96,03	1	2
PIVOT850	BRUT	50x50	107,61	1	2



A180000 Capot pour pivots à sceller ou à cheiller

Code		L	l	H	Tarif HT en €		Cat.
A180000	BRUT	105	40	61	6,33	1	2

Ferrures pour portails métalliques



CL000.. IDEFIX® - Articulation de portail - Bague laiton

Code		H	L fileté	Ø Tige fileté	Dim. bague laiton	Réglage E1	Réglage E2	Charge max /Pivot	Tarif HT en €		Cat.
CL00000	BRUT	25	80	12	12x22x8	50	13	50 kg	69,01	1	2
CL00010	BRUT	28	90	16	16x30x9	50	16	60 kg	74,46	1	2
CL00020	BRUT	36	110	20	20x38x9	60	22	75 kg	87,68	1	2
CL00030	BRUT	36	140	24	24x46x9	80	22	85 kg	122,89	1	2

